

QUIK DRIVE®

QD2000SDS

OPERATING INSTRUCTIONS



QD2000SDS, QD2000MSDS, QD2000SDSF

SAVE THESE INSTRUCTIONS

QUICK START INSTRUCTIONS Complete instructions inside



DRIVING SCREWS

Be sure screwgun is in FORWARD.

Start screwgun before applying driving pressure.

Continue to apply pressure, keeping bit engaged until screw is fully driven and clutch releases.

Keep screwgun running between screws.

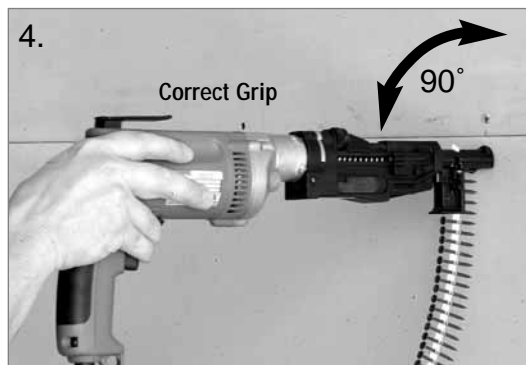

Use With Or Without The "Stand-up" Extension

800-999-5099

www.strongtie.com

PARTS - SCHEMATIC - COMPONENTS

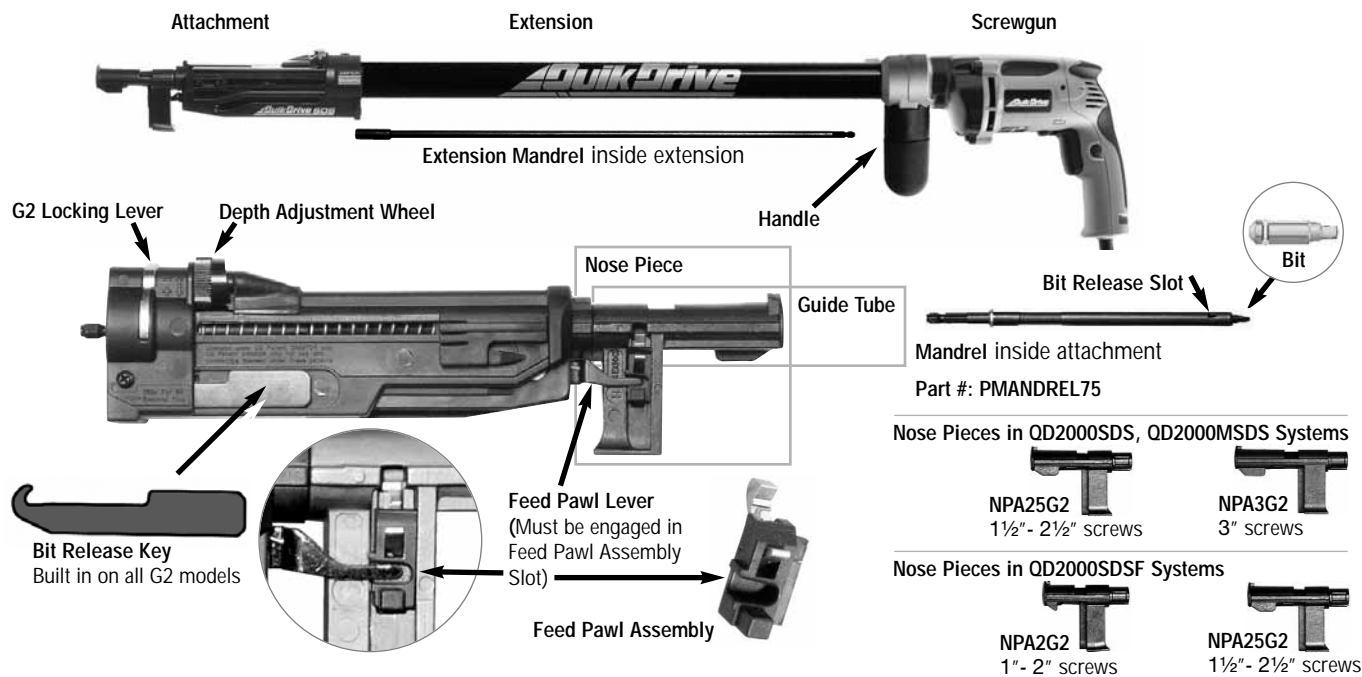

Use the correct driving bit.

The bit(s) included in each box of Quik Drive® screws should drive the entire box. Variations in materials and driving technique can cause excessive wear. Additional bit packs are available for purchase. Reference the description on the bit sticker in your box of screws or the screw box label to ensure correct selection.

Quik Drive Systems utilize five recess drive types and sizes.

Drive Type / Size	Bit	
#2 square drive	BIT2S	for most screws with #2 recess and interior grade coating
#2U (<i>Undersized</i>)	BIT2SU	for most screws with #2 recess and exterior grade coating
#3 square drive	BIT3S	for most screws with #3 recess and interior grade coating
#3U (<i>Undersized</i>)	BIT3SU	for most screws with #3 recess and exterior grade coating
#2 phillips	BIT2P	for all Quik Drive screws with phillips recess

TROUBLESHOOTING GUIDE

Quik Drive tools are easy to use. As with any power tool, there are a few basic things to remember.

PROBLEM	SOLUTION
Screws won't drive. They spin for a second, then fall over on their side. Little or no penetration.	<i>Make sure the screwgun is not in reverse.</i>
Screws won't drive completely. They go down about halfway, then the bit spins out.	<i>Check to be sure you are using the correct bit for the type of screws you are driving. Check for bit wear. It may be time to install a new bit. Push harder when driving.</i>
Screws won't drive completely. They are almost completely driven but won't countersink completely.	<i>Check the depth adjustment on the attachment. Reset if necessary. You may have missed the substrate. Example: In flooring, this will occur if you miss the joist.</i>
Screws don't advance properly causing tool to jam.	<i>Use only Quik Drive® brand collated screws. Be sure the screw strip is inserted correctly - pointed end first. Lift the tool completely off the work surface after driving each screw. Don't drag screw strips on the work surface as you move to the next position. Be sure the feed pawl assembly is intact and feed lever is engaged.</i>

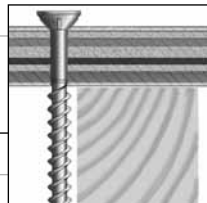

OPERATING INSTRUCTIONS

ATTACH ADAPTOR TO YOUR SCREWGUN

(If you purchased a complete system with screwgun; skip this step)

- Remove nose-cone and bit holder from your screwgun according to manufacturer's directions (most will pull straight off).
- Replace with Quik Drive® adaptor made for the screwgun. Follow specific instructions included with Quik Drive adaptor.



INSTALL CORRECT BIT

- Be sure you have the correct bit for the screws you are driving. It's a good practice to install one of the free bits included with our screws when you open a new box.
- Remove the attachment and pull the mandrel from the unit. Extend the bit release key and pry out the old bit. Put a new bit in place and push against a solid surface until it snaps in place.



CONNECT ATTACHMENT TO SCREWGUN OR EXTENSION

- Insert mandrel in extension or screwgun, slide attachment on and push tight - until the locking lever snaps in place.
- You can rotate the attachment any way that is desired.
- New tools may be tight and hard to lock in place. If so, just put the nose against a solid surface and push down sharply (see photo at far right).



Seat mandrel first, then add attachment

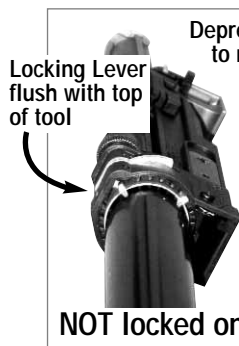

NOT locked on

Check locking lever position to be sure attachment is locked on
To remove, release locking lever and pull

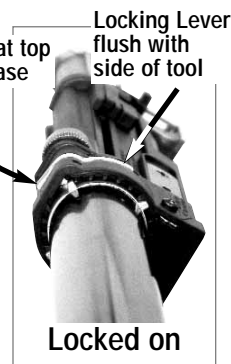

Locked on

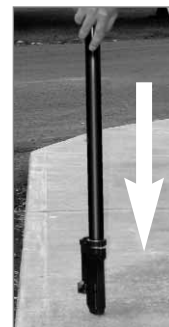

If new tool is hard to lock on, place nose on solid surface and push down

ATTACH EXTENSION TO SCREWGUN

- Turn the Clamping Handle in the "off" direction (clockwise) to move the internal clamp out of the way.
- Insert the screwgun, with G2 Adaptor attached, into the end of the extension. Push tight and tighten Clamping Handle.
- If it won't fully insert, start the screwgun slightly until the drives mesh.

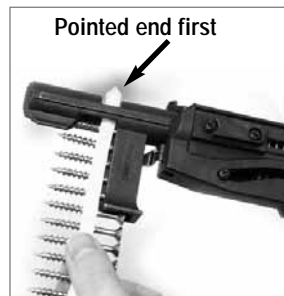

Pointed end first

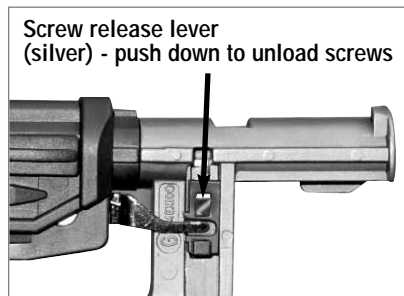

Screw release lever (silver) - push down to unload screws

LOADING AND UNLOADING SCREWS

Insert a screw strip pointed end first, until they click in place. Push release lever to unload.

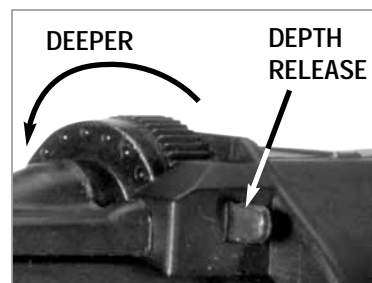

DEEPER

DEPTH RELEASE

SET DEPTH

Press DEPTH RELEASE to adjust. Test in scrap material to achieve optimal setting.

READ AND FOLLOW ALL INSTRUCTIONS
 WHEN SERVICING USE ONLY IDENTICAL QUIK DRIVE® REPLACEMENT PARTS.
 ATTENTION - Please see screwgun manufacturer's instructions for safe use of electric power tools.

QUIK CHANGE NOSEPIECE

- Gives you the ability to drive the full range of screw lengths available for your system.
- Just twist the nose counterclockwise and pull it off.
- Push the desired nosepiece completely into tool body (fig. c.) and twist clockwise into position.
- Make sure the FEED LEVER aligns with the FEED LEVER RECESS.

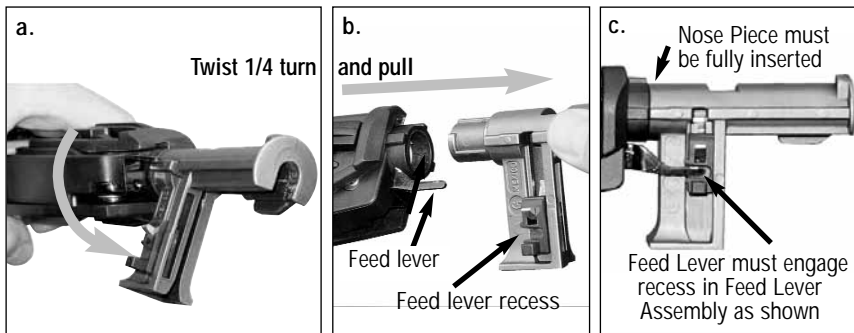

QD2000SDS, QD2000MSDS, and QD2000SDSF Systems are covered by one or more of the following patents.

5,337,635	5,531,143	5,699,704	5,927,163	6,089,132	6,439,085	D391,135
5,351,586	5,568,753	5,884,541	5,934,162	6,244,140	6,453,780	
5,469,767	5,570,618	5,918,512	6,055,891	6,363,818	6,959,630	

LIMITED LIFETIME WARRANTY

This Limited Lifetime Warranty applies to all Quik Drive products (except the QDA158 product) and must be read in conjunction with the General Notes, Terms and Conditions of Sale, and Corrosion Resistance information contained in the current Quik Drive catalog and at www.strongtie.com/info, along with any information provided with a Simpson product. Screwguns that may be supplied with the Products are manufactured by others and are warranted by their respective manufacturers. Simpson Strong-Tie Company Inc. ("Simpson") warrants the Products to the original purchaser to be free from substantial defects in material, manufacturing, and design for the lifetime of the product, if properly stored, maintained and used. This Warranty does not cover normal wear and tear or any Product that was: (1) purchased other than from an authorized Simpson dealer, retailer or distributor; (2) modified or altered; (3) used with any fasteners other than authentic Quik Drive fasteners; (4) improperly serviced; or (5) subject to negligence, excessive uses, or any use not in accordance with the printed materials provided with the Product as determined by Simpson. Purchaser's sole remedies are replacement or repair upon return to Simpson with proof of purchase (shipping prepaid by purchaser). To obtain warranty service go to www.strongtie.com or contact Simpson promptly at (800) 999-5099. The repaired or replaced Product is warranted under the terms of this Warranty.

WHERE LAWFUL, SIMPSON DISCLAIMS ALL OTHER WARRANTIES, INCLUDING BUT NOT LIMITED TO IMPLIED WARRANTIES OF MERCHANTABILITY AND FITNESS FOR A PARTICULAR PURPOSE. IN NO EVENT WILL SIMPSON BE LIABLE FOR INCIDENTAL, CONSEQUENTIAL, PUNITIVE OR SPECIAL DAMAGES OR DIRECT OR INDIRECT LOSS OF ANY KIND, INCLUDING BUT NOT LIMITED TO PROPERTY DAMAGE AND PERSONAL INJURY. SIMPSON'S ENTIRE LIABILITY IS LIMITED TO THE PURCHASE PRICE OF THIS PRODUCT. SOME STATES DO NOT ALLOW LIMITATIONS ON IMPLIED WARRANTIES, OR THE EXCLUSION OR LIMITATION OF INCIDENTAL OR CONSEQUENTIAL DAMAGES, SO THE ABOVE LIMITATIONS AND EXCLUSIONS MAY NOT APPLY TO YOU. THIS LIMITED WARRANTY GIVES YOU SPECIFIC LEGAL RIGHTS, AND YOU MAY ALSO HAVE OTHER RIGHTS THAT VARY FROM STATE TO STATE.

Home Office 5956 W. Las Positas Blvd. Pleasanton, CA 94588 Tel: 925/560-9000 Fax: 925/847-1603	Northwest USA 5151 S. Airport Way Stockton, CA 95206 Tel: 209/234-7775 Fax: 209/234-3868	Southwest USA 260 N. Palm Street Brea, CA 92821 Tel: 714/871-8373 Fax: 714/871-9167	Southeast USA 2221 Country Lane McKinney, TX 75069 Tel: 972/542-0326 Fax: 972/542-5379	Northeast USA 2600 Int'l Street Columbus, OH 43228 Tel: 614/876-8060 Fax: 614/876-0636	Quik Drive Branch 436 Calvert Drive Gallatin, TN 37066 Tel: 615/230-8788 Fax: 615/451-9806
---	---	--	---	---	---

